

4

**toilet paper
dispensers**

we wrap you
in comfort



TOILET PAPER DISPENSERS

TOILET PAPER DISPENSERS

For Jumbo rolls, for 2 or 3 standard rolls and for folded tissue paper.

Mediclinics has a tradition in functional stainless steel system-free toilet paper dispensers. Without them a toilet cubicle is simply unthinkable. Big-capacity space-saving Jumbo roll dispensers? Mediclinics traditional dispensers for 2 rolls or for 3 rolls? Or dispensers for folded toilet tissue paper? All in solid stainless steel AISI 304?

Mediclinics has it all. Just make your choice.

High capacity and space saving dispensers for small rooms.

- For big Industrial rolls and for standard commercial rolls
- Easy filling; no internal moving parts or sharp edges
- Easily visible from outside when it is time to refill
- Safe and secure lock-systems protecting against misuse of paper
- Fully stainless steel (AISI 304) dispensers with strong welded construction
- Stainless steel lids solidly hinged to the bodies
- Adequate braking systems adjustable for different paper qualities
- The dispensers accept paper rolls with different core sizes

TOILET PAPER DISPENSERS industrial

paper roll Ø 230 mm

PR2783

capacity: **max. roll Ø230 mm**

material: steel

finish: white epoxy



NEW

PR2783C

capacity: **max. roll Ø230 mm**

material: AISI 304 stainless steel

finish: bright



NEW

PR2783CS

capacity: **max. roll Ø230 mm**

material: AISI 304 stainless steel

finish: satin

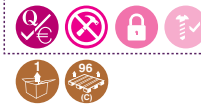

NEW

TOILET PAPER DISPENSERS industrial paper roll Ø 230 mm

PR2783 · PR2783C · PR2783CS | | | | COMPONENTS AND MATERIALS

- Stylish design suitable for every washroom.
- One-piece body.
- One-piece lid, which can be swung down for replenishment.
- Backplate with multiple slots for easy installation.
- Removable shaft allows variety of paper refills. (2 positions)
- Slot at the front for viewing content level.
- Shaft with inertial anti-spin retainer.
- Backplate with an anti-moisture support.
- Lock with standard mediclinics key.

**ALSO
AVAILABLE
IN BLACK
FINISH**

PR2783 · PR2783C · PR2783CS | | | | TECHNICAL SPECIFICATIONS

Thickness of body and lid	0.8 mm
Weight (empty)	1.25 Kg
Paper roll capacity	max. Ø 230 mm
Toilet roll width	max. 115 mm
Toilet roll core	max. Ø 45 mm
Recommended installation height	65-75 cm at lower point
Installation height	70 cm at lower point

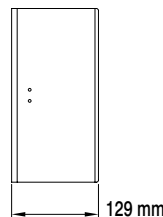
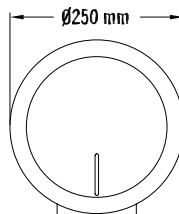

TOILET PAPER DISPENSERS

industrial

Paper roll Ø 230 mm



PR0783

capacity: **max. roll Ø230 mm**

material: steel

finish: white epoxy



PR0783C

capacity: **max. roll Ø230 mm**

material: AISI 304 stainless steel

finish: bright



PR0783CS

capacity: **max. roll Ø230 mm**

material: AISI 304 stainless steel

finish: satin



PR0783 · PR0783C · PR0783CS | | | | COMPONENTS AND MATERIALS

- Backplate with an anti-moisture support.
- One-piece body.
- One-piece lid, which can be swung down for replenishment.
- Slot at the front for viewing content level.
- AISI 304 stainless steel shaft with inertial anti-spin retainer to optimise the dispensing of toilet paper. Its diameter allows the use of standard toilet paper if necessary.
- Lock with standard mediclinics® key.

PR0783 · PR0783C · PR0783CS | | | | TECHNICAL SPECIFICATIONS

Thickness of body and lid	0.8 mm
Weight (empty)	1.3 Kg
Paper roll capacity	max. Ø 230 mm
Toilet roll width	max. 115 mm
Toilet roll core	Ø 45 & Ø 56 mm
Recommended installation height	65-75 cm at lower point
Installation height	70 cm at lower point

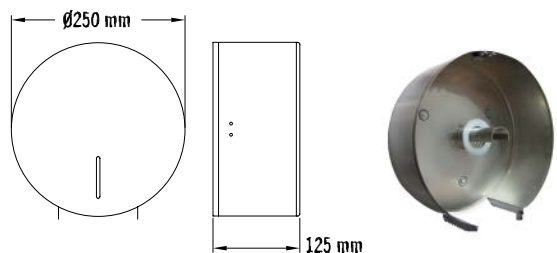

TOILET PAPER DISPENSERS industrial

paper roll Ø 275 mm

PR2787

capacity: **max. roll Ø275 mm**

material: steel
finish: white epoxy



PR2787C

capacity: **max. roll Ø275 mm**

material: AISI 304 stainless steel
finish: bright

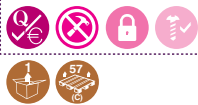

PR2787CS

capacity: **max. roll Ø275 mm**

material: AISI 304 stainless steel
finish: satin



KIT 2789

optional shaft for 3 rolls

material: thermoplastic
finish: black

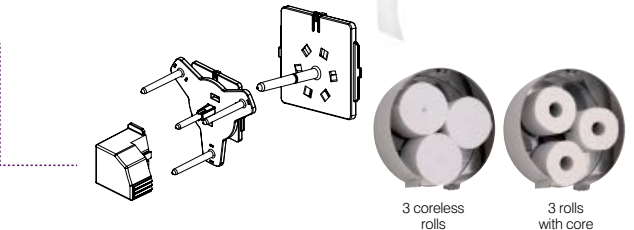

optional accessory available separately

PR2787 · PR2787C · PR2787CS | | | COMPONENTS AND MATERIALS

- Stylish design suitable for every washroom.
- One-piece body.
- One-piece lid, which can be swung down for replenishment.
- Backplate with multiple slots for easy installation.
- Removable shaft allows variety of paper refills. (2 positions)
- Slot at the front for viewing content level.
- Shaft with inertial anti-spin retainer.
- Backplate with an anti-moisture support.
- Lock with standard mediclinics key.

**ALSO
AVAILABLE
IN BLACK
FINISH**

PR2787 · PR2787C · PR2787CS | | | TECHNICAL SPECIFICATIONS

Thickness of body and lid	0.8 mm
Weight (empty)	1.70 Kg
Paper roll capacity	max. Ø 274 mm
Toilet roll width	max. 115 mm
Toilet roll core	max. Ø 45 mm
Recommended installation height	65-75 cm at lower point
Installation height	70 cm at lower point

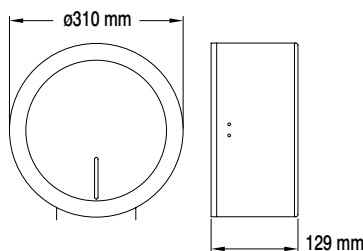

TOILET PAPER DISPENSERS industrial paper roll Ø 275 mm

TOILET PAPER DISPENSERS

industrial

Paper roll Ø 275 mm



PR0787

capacity: **max. roll Ø275 mm**

material: steel
finish: white epoxy



PR0787C

capacity: **max. roll Ø275 mm**

material: AISI 304 stainless steel
finish: bright



PR0787CS

capacity: **max. roll Ø275 mm**

material: AISI 304 stainless steel
finish: satin

PR0787 · PR0787C · PR0787CS | | | | COMPONENTS AND MATERIALS

- One-piece body.
- One-piece lid, which can be swung down for replenishment.
- Backplate with an anti-moisture support.
- Slot for viewing content level on the front.
- AISI 304 stainless steel shaft with inertial anti-spin retainer to optimise the dispensing of toilet paper. It's diameter allows the use of a standard paper roll in case of need.
- Lock with standard mediclinics® key.

PR0787 · PR0787C · PR0787CS | | | | TECHNICAL SPECIFICATIONS

Thickness of body and lid	0.8 mm
Weight (empty)	1.75 Kg
Paper roll capacity	max. Ø275 mm
Toilet roll width	max. 115 mm
Toilet roll core	Ø 45 & Ø 56 mm
Recommended installation height	65-75 cm at lower point
Installation height 	70 cm at lower point

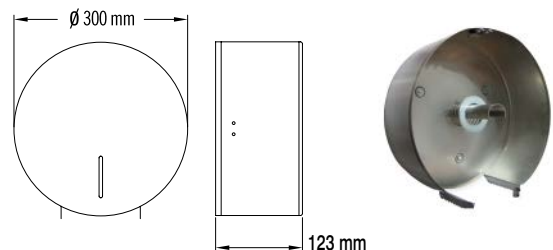

TOILET PAPER DISPENSERS standard/adaptable to industrial

3 paper rolls/paper roll Ø 275 mm

PR0789

capacity: **3 rolls**
material: steel
finish: white epoxy

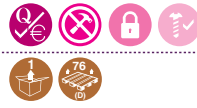

PR0789C

capacity: **3 rolls**
material: AISI 304 stainless steel
finish: bright



PR0789CS

capacity: **3 rolls**
material: AISI 304 stainless steel
finish: satin



9391005SMD

optional shaft for industrial roll
material: thermoplastic
finish: black
optional accessory available separately

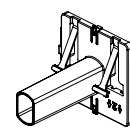
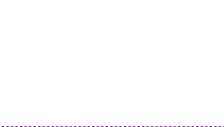

Paper reel

PR0789 · PR0789C · PR0789CS · 9391005SMD | | | COMPONENTS AND MATERIALS

PR0789 · PR0789C · PR0789CS:

- One-piece body.
- One-piece lid, which can be swung down for replenishment.
- Backplate with an anti-moisture support.
- Modular thermoplastic shaft allows three standard rolls to be fitted, core or coreless rolls.
- The roll descends automatically once the previous one has been finished.

- Slot at the front for viewing content level.
- Lock with standard mediclinics® key.

9391005SMD:

- Optional thermoplastic shaft for industrial roll with inertial anti-spin retainer to optimise dispensing of toilet paper. Replaces the original three standard roll shaft, allowing the use of industrial toilet rolls.

PR0789 · PR0789C · PR0789CS · 9391005SMD | | | TECHNICAL SPECIFICATIONS

PR0789/789C/789CS

Body thickness	0.8 mm
Lid thickness	0.8 mm
Weight (empty)	1.75 Kg
Toilet roll width	max. 115 mm
Toilet paper roll capacity	3 u.
Toilet roll holder (axis optional)	max. Ø275 mm
Toilet roll core	Ø 45 & Ø 56 mm
Recommended installation height	65-75 cm at lower point
Installation height	70 cm at lower point

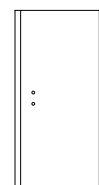
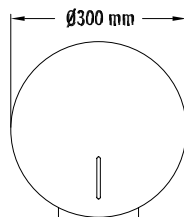

123 mm



3 coreless rolls



3 rolls with core

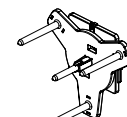

Shaft for 3 rolls

TOILET PAPER DISPENSERS industrial/adaptable to industrial three paper rolls/paper roll Ø 275 mm

TOILET PAPER DISPENSERS

standard

2/3 u paper rolls



PR0784



PR0781

capacity: **3 rolls**



PR0784

capacity: **2 rolls**



material: steel
finish: white epoxy



PR0781C



PR0781C

capacity: **3 rolls**



PR0784C

capacity: **2 rolls**



material: AISI 304 stainless steel
finish: bright



PR0784CS



PR0781CS

capacity: **3 rolls**



PR0784CS

capacity: **2 rolls**



material: AISI 304 stainless steel
finish: satin

PR0781 · PR0784 · PR0781C · PR0784C · PR0781CS · PR0784CS | | | COMPONENTS AND MATERIALS

- One-piece body.
- One-piece, weld-free lid.
- Slots on the sides and content viewer at the front.
- The toilet paper roll descends when the previous one has been finished by simply putting the hand through the side slot.
- Lock with standard mediclinics® key.

PR0781 · PR0784 · PR0781C · PR0784C · PR0781CS · PR0784CS | | | TECHNICAL SPECIFICATIONS

PR0781/781C/781CS · PR0784/784C/784CS	
Thickness of body and lid	0.8 mm
Toilet paper roll	max. Ø105 mm
Recommended installation height	65-75 cm at lower point
Installation height	70 cm at lower point
PR0781/781C/781CS	
Toilet paper roll capacity	3 u.
Weight (empty)	1.3 Kg
PR0784/784C/784CS	
Toilet paper roll capacity	2 u.
Weight (empty)	0.9 Kg

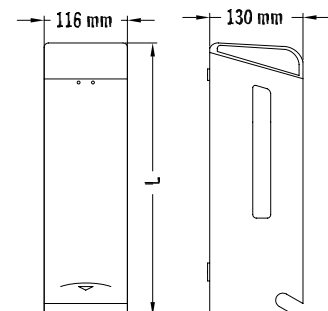

L: PR0781/781C/781CS: 380 mm
PR0784/784C/784CS: 290 mm

TOILET PAPER DISPENSERS standard

2 u paper rolls

PR2784

Capacity: **2 rolls**

material: steel
finish: white epoxy

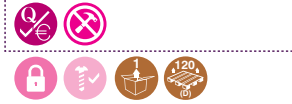

PR2784C

Capacity: **2 rolls**

material: AISI 304 stainless steel
finish: bright

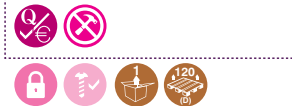

PR2784CS

Capacity: **2 rolls**

material: AISI 304 stainless steel
finish: satin

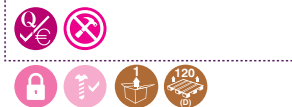

2 units paper rolls

TOILET PAPER DISPENSERS

PR2784 · PR2784C · PR2784CS COMPONENTS AND MATERIALS

- One-piece body.
- One-piece, weld-free lid.
- Slots on the sides and content viewer at the front.
- Lock with standard Mediclinics key.
- The toilet paper roll descends when the previous one has been finished by simply putting the hand through the side slot.

PR2784 · PR2784C · PR2784CS TECHNICAL SPECIFICATIONS

PR2784 · PR2784C · PR2784CS

Lid & Body Thickness	0,8 mm
Paper Roll	máx. Ø110 mm
Roll Paper Capacity	2 u.
Weight (empty)	1,1 kg.
Recommended installation	65-75 cm at lower point
Installation Height	70 cm at lower point

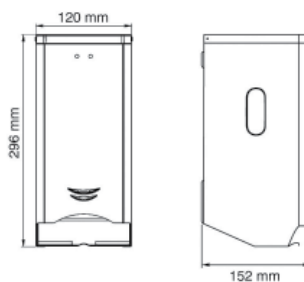

**ALSO
AVAILABLE
IN BLACK
FINISH**

TOILET PAPER DISPENSERS

folded toilet tissue paper / seat covers



DTH100

capacity: **400 sheets (approx.)**

material: steel
finish: white epoxy



DTH100C

capacity: **400 sheets (approx.)**

material: AISI 304 stainless steel
finish: bright



DTH100CS

capacity: **400 sheets (approx.)**

material: AISI 304 stainless steel
finish: satin



DCA100CS

capacity: **250 seat covers.**

material: AISI 304 stainless steel
finish: satin

DTH100 · DTH100C · DTH100CS · DCA100CS

COMPONENTS AND MATERIALS

- One-piece body in AISI 304 stainless steel, with lid for refilling.
- One-piece, weld-free lid.
- Content viewer at the front.
- Lock with standard Mediclinics® key.

DCA100CS

- One-piece, weld-free body.
- Opening at the top to replace cover sheets box.
- Easy pull opening system.

DTH100 · DTH100C · DTH100CS · DCA100CS

TECHNICAL SPECIFICATIONS

DTH100 · DTH100C · DTH100CS

Body thickness	0.8 mm
Front thickness	0.8 mm

DCA 100CS

Body thickness	0.8 mm
Front thickness	0.8 mm

DTH100 · DTH100C · DTH100CS

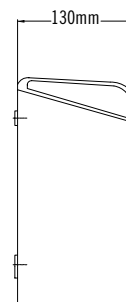
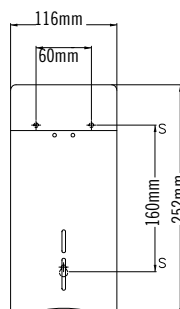

DCA 100CS

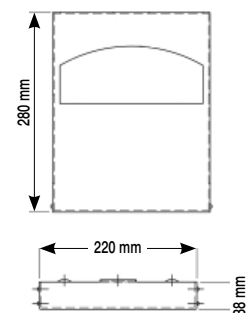

TOILET PAPER DISPENSERS

sanitary bag dispenser

DBH100

capacity: **50 bags (approx.)**

material: steel

finish: white epoxy

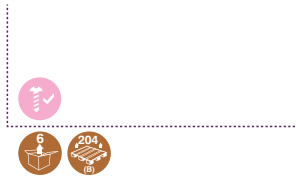

DBH100C

capacity: **50 bags (approx.)**

material: AISI 304 stainless steel

finish: bright

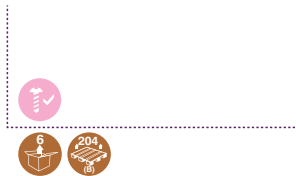

DBH100CS

capacity: **50 bags (approx.)**

material: AISI 304 stainless steel

finish: satin



AI0920C

sanitary bag dispenser

material: AISI 304 stainless steel

finish: bright



AI0920CS

sanitary bag dispenser

material: AISI 304 stainless steel

finish: satin

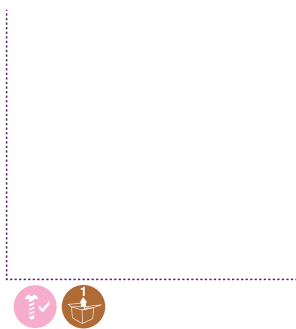

TOILET PAPER DISPENSERS sanitary bag/folded toilet tissue paper

DBH100 · DBH100C · DBH100CS · AI0920C · AI0920CS | COMPONENTS AND MATERIALS

- One-piece body in AISI 304 stainless steel.
- **AI0920C · AI0920CS:**
 - Suitable for feminine sanitary bag refill boxes of 136 x 91 x 24 mm.

DBH100 · DBH100C · DBH100CS · AI0920C · AI0920CS | TECHNICAL SPECIFICATIONS

DBH100 · DBH100C · DBH100CS

Body thickness 0.8 mm

AI0920C · AI0920CS

Body thickness 1 mm

DBH100 · DBH100C · DBH100CS

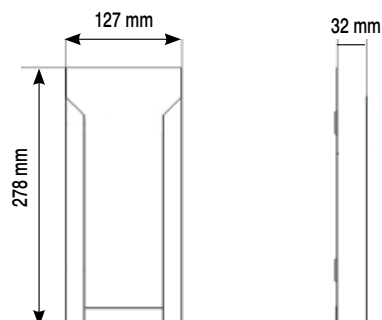



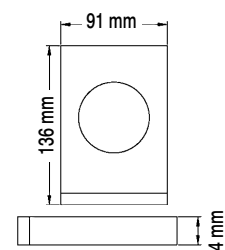



AI0920C · AI0920CS

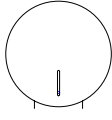

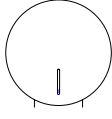
TOILET PAPER DISPENSERS

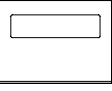
table

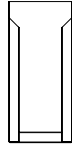
	MODEL	MATERIAL / FINISH			PAPER TYPE			
		Steel white epoxy	AISI 304 Stainless steel bright	AISI 304 Stainless steel Satin	STANDARD		ROLL (INDUSTRIAL)	
					CAPACITY		CAPACITY	
					2 rolls	3 rolls	Ø230 mm	Ø275 mm
	PR2783	•					•	
	PR2783C		•				•	
	PR2783CS			•			•	
	PR0783	•					•	
	PR0783C		•				•	
	PR0783CS			•			•	
	PR2787	•						•
	PR2787C		•					•
	PR2787CS			•				•
	PR0787	•						•
	PR0787C		•					•
	PR0787CS			•				•
	PR0789	•				•		•
	PR0789C		•			•		•
	PR0789CS			•		•		•
	PR0781	•				•		
	PR0784	•			•			
	PR0781C		•			•		
	PR0784C		•		•			
	PR0781CS			•		•		
	PR0784CS			•	•			
	PR2784	•			•			
	PR2784C		•		•			
	PR2784CS			•	•			
	DCA100CS			•				
	DTH100	•						
	DTH100C		•					
	DTH100CS			•				
	DBH100	•						
	DBH100C		•					
	DBH100CS			•				
	AI0920C		•					
	AI0920C			•				

TOILET PAPER DISPENSERS

table

PAPER TYPE			SHAPE		LOCK WITH KEY	SUITABLE FOR			MODEL
Toilet seat cover	Sanitary towels	Sanitary Bags	Rectangular	Round		Gyms and Sport centres	Hospitals and Health Centres facilities	Hotels and other accommodation	
				●	●		●	●	PR2783
				●	●	●	●	●	PR2783C
				●	●	●	●	●	PR2783CS
				●	●		●	●	PR0783
				●	●	●	●	●	PR0783C
				●	●	●	●	●	PR0783CS
				●	●		●	●	PR2787
				●	●	●	●	●	PR2787C
				●	●	●	●	●	PR2787CS
				●	●		●	●	PR0787
				●	●	●	●	●	PR0787C
				●	●	●	●	●	PR0787CS
				●	●		●	●	PR0789
				●	●	●	●	●	PR0789C
				●	●	●	●	●	PR0789CS
			●		●	●	●	●	PR0781
			●		●	●	●	●	PR0784
			●		●	●	●	●	PR0781C
			●		●	●	●	●	PR0784C
			●		●	●	●	●	PR0781CS
			●		●	●	●	●	PR0784CS
			●		●	●	●	●	PR2784
			●		●	●	●	●	PR2784C
			●		●	●	●	●	PR2784CS
●			●			●	●	●	DCA100CS
	●		●		●	●	●	●	DTH100
	●		●		●	●	●	●	DTH100C
	●		●		●	●	●	●	DTH100CS
		●	●				●	●	DBH100
		●	●				●	●	DBH100C
		●	●				●	●	DBH100CS
		●	●					●	AI0920C
		●	●					●	AI0920C

TOILET PAPER DISPENSERS table